

KOBLOCH
METAL AT ITS BEST

Commercial Mailbox Solutions

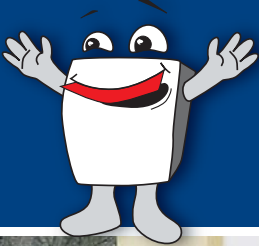

Multi-unit mailboxes have to fulfill several expectations. First and foremost is function: the delivered mail has to be kept secure and dry. Larger parcels should fit well. This is regulated by the EN 13724. If there is less space, smaller mailboxes must be used. But, regardless of the size, quality and security come first. Other important selection criteria are stability, durability and longevity. Because mailboxes are installed in the entrance area, the design must be convincing. And last but not least, the boxes should provide value for money.

KOBLOCH stands for multi-unit mailboxes which consistently exceed these requirements. **In our complete product line you will find practically every mailbox imaginable – for the family house as well as for the Office Block, from the solid model for the factory to the precious wood-panelled designer mailbox for the sophisticated owner.** All of our mailboxes have high quality and meticulous processing in common. Built solidly and designed to be longlasting through a versatile modular construction system to accommodate all construction conditions.

The following pages will provide information to help achieve the best solution for your mailbox requirements

Our range of standard RAL colours can be found on page 6
Additional colours are available from our stock of more than 200 different RAL- and special shades. Processing is also possible for materials like brass and PVD-coated stainless steel and we will be pleased to discuss any individual requirements

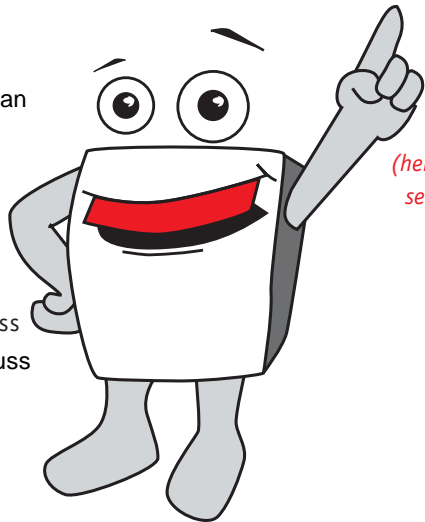

Multi-unit Mailboxes

Experience a quality that will convince you.

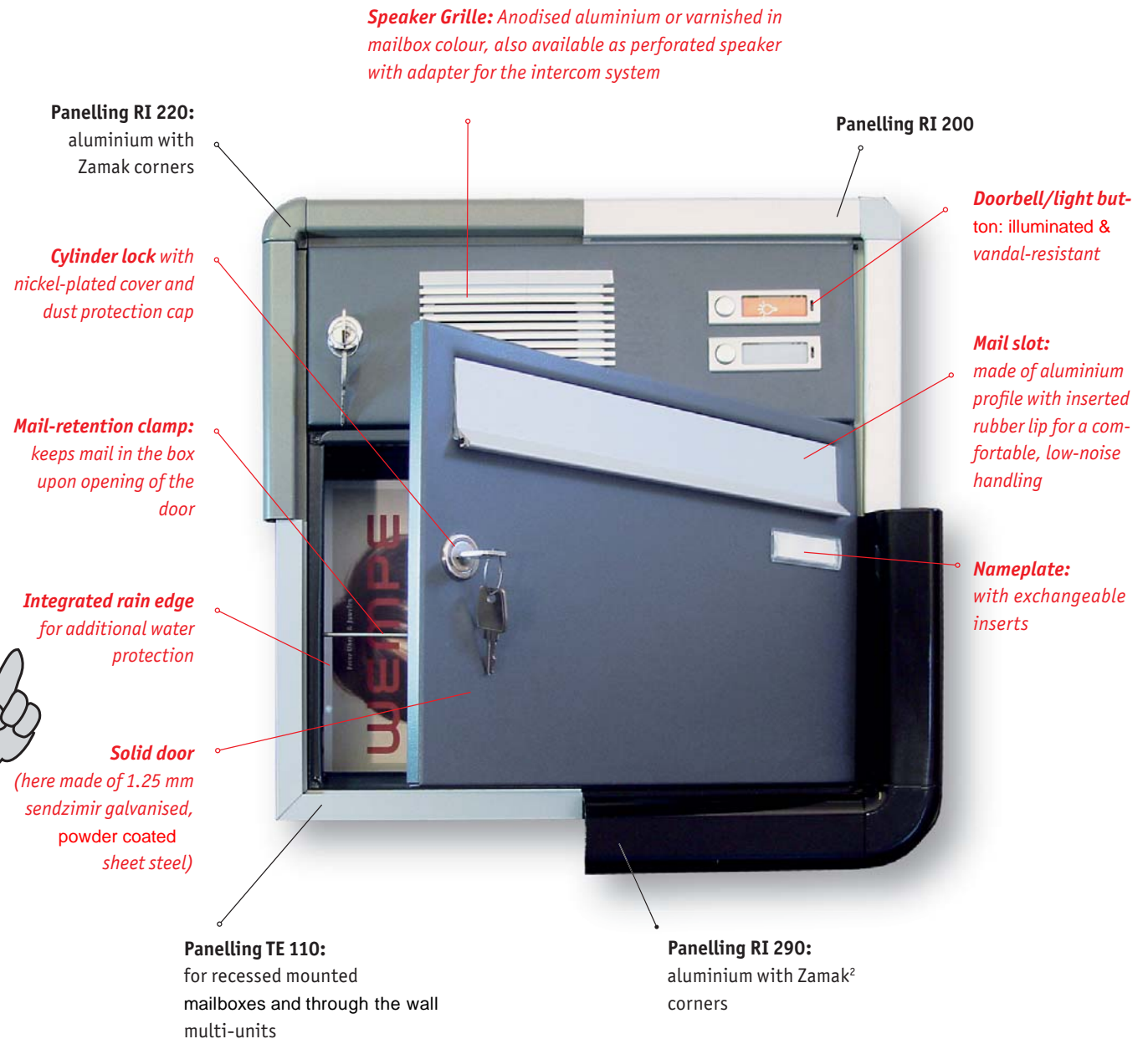

There are many **free-standing multi-units** on the market. It's just that ours are also long-standing.

Our free-standing multi-units are flexible, practical and adaptable to most situations. At **KOBLOCH** we do it even better.

Our products offer both durability and value for money backed up with a 5 year guarantee against corrosion.

Our catalogue provides a comprehensive range of individual and multi-unit boxes and a complete list of accessories..



fig. 1:
Multi-unit with vertical mailboxes, panelling RI 240 V, stand SO 401 and stainless steel roof "simple" for multi-units

fig. 2:
Panelling RI 220 H, stand SO 400, system assembly possible with labels and address plaques upon request



fig. 2



fig. 3

fig. 3:
Multi-unit with horizontal mailboxes, panelling Sommerwind RI 243 H and stand SO 441



fig. 4

fig. 4:
Multi-unit with horizontal boxes, panelling RI 244 V and stand SO 241, stainless steel

Here's a tip
Don't forget:
free-standing multi-units are also available with rear retrieval



SURFACE AND RECESSED MOUNTED MULTI-UNITS, FENCE MOUNTED MULTI-UNITS, MULTI-UNITS FOR DOOR SIDES

4

They're always on top of it, these surface mounted multi-unit mailboxes.

Ideal for internal or external surface mounting, these units are available with either horizontal or vertical mailboxes to optimise the space available.

There are a variety of surrounds to enhance any installation. the surface mounted multi-units are ideal for entrance halls and lobby areas and are fast and easy to install with quality you can rely on.

If you need any help with your design
We are always happy to assist



fig. 1:
Recessed mounted multi-units with horizontal mailboxes and plaster-cover frame TE 110



fig. 2:
Surface mounted multi-unit with horizontal mailboxes and panelling RI 220 H



fig. 3:
Surface mounted multi-unit with vertical mailboxes, panelling RI 220 V and integrated message box



Here's a tip:
Please note that surface mounted multi-units with horizontal mailboxes can be up to 380 mm deep and because of this they could constrict driveways and footpaths, especially in stairways. In this case we recommend the use of vertical mailboxes.

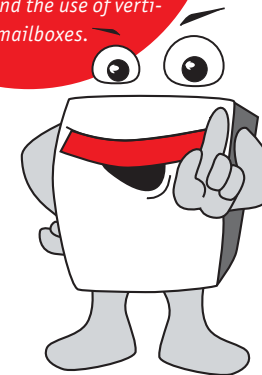

**Recessed Mounted:
One can sink to this level.**

Stylish and unobtrusive, our mailboxes fit into most architectural surroundings. With a wide range of designs available we sure to have the right combination for you. Our choice of plaster - cover frames will ensure that your mailbox unit will always have a professional finish

To achieve this you don't have to make any concessions with the multi-unit's equipment or functionality. from an almost limitless number of possibilities we can supply the right solution for you . We are happy to help!

fig. 4:
Recessed mounted multi-unit with vertical mailboxes and plaster cover frame TE 120



Only the mail is allowed to go through the fence.

Whenever there's a fence on hand, it's worth thinking about integrating a multi-unit mailbox into it. This smart alternative offers the following advantages.

First of all, construction on your house or property is not required. Secondly, fence mailboxes offer you maximum security concerning the mail delivery reducing the need for anyone to come onto your property



fig. 1:
Mailbox unit **Likno**
with newspaper holder

fig. 1

fig. 2:
fence letterbox system with horizontal boxes and
panelling **RI 241 H**; roof: special design as per
customer specification



fig. 2



**Here's
a tip:**

The fence mounting kit
facilitates multi-unit
installation

Even with the smallest door, you've got mail.

Rear retrieval mailbox units provide a solution for secure mail delivery to commercial and residential premises.



"Through the wall" mailbox units offer the perfect solution for installations that require the mail to be delivered in the traditional way with internal individual mail collection at multi-occupancy premises. These units minimise the risk of vandalism and incorporate a noise damper within the letterflap. Our specialised customer service team are always on hand to help.



fig. 3:
Outside view of a multi-unit
for door sides with vertical
mailboxes



fig. 4:
Outside view - Multi-unit for door sides
with horizontal mailboxes

A breakthrough for the mail: Thru-wall Multi-unit Mailboxes.

Secure mail delivery through masonry or brickwork is easily facilitated using these mailbox units. To achieve this we are able to provide a multi-unit mailbox to be integrated into the masonry or masonry columns.

Together with the wide range of plaster cover frames these boxes offer a truly professional finish.



fig. 1

fig. 1:
Outside view of a thru-wall multi-unit with
panelling TE 130



fig. 2

fig. 2:
Outside view of a thru-wall
multi-unit

Show Your True Colours!

Our colours and surfaces comply with the highest standards and requirements. Whether anodised aluminium, RAL powder coated or rust-free stainless steel, we stand behind our quality. You haven't found the right colour tint in our standard offer? No problem: Simply select the right colour palette out of the RAL colour tray and order it as a custom colour. We'd also be happy to advise you with your selection. The shine of the colours remain intact for a long time thanks to the high-quality weather and UV-resistant powder coating used. For all RAL colours out of our standard offer, we calculate a 20 % additional cost for all powder coated parts. The pictured RAL and anodised colour tints are only approximations. For the exact colour tint, the RAL colour cards and anodised pattern are binding.

Standard RAL Colour Tints

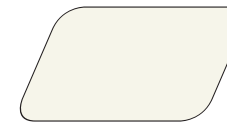

RAL 9016 Traffic-white



RAL 3020 Traffic-red

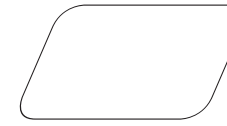

RAL 9010 Pure-white



RAL 6005 Moss-green

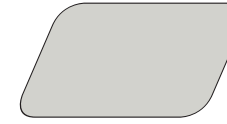

RAL 7035 Light-grey



RAL 5002 Ultramarine

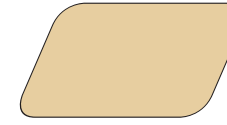

RAL 1014 Ivory



RAL 8017 Chocolate-brown

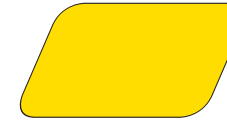

RAL 1018 Zinc-yellow



RAL 7016 Charcoal-grey

Standard anodised colour tints for aluminium fronts

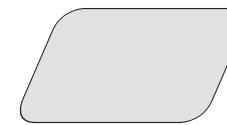

01 Silver EV 1

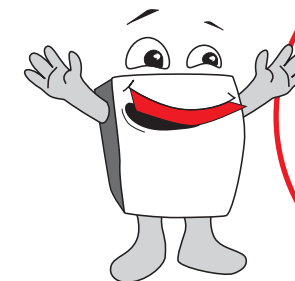

Here's a tip!

As a result of the most modern, environmentally friendly varnishing facilities, we can offer you more colours in our standard range - without a price increase.

Panelling Types for Surface Mounted Multi-units

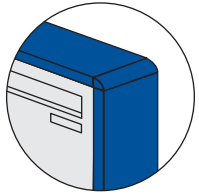

RI 220 H



RI 240 H

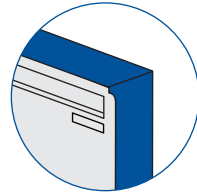

RI 241 H

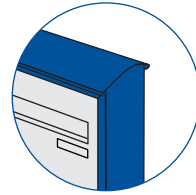

RI 243 H

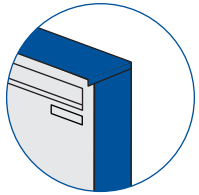

RI 244 H



RI 245 H



RI 290 H

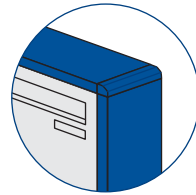

RI 200 Y

Plaster Cover Frames for Recessed Mounted Multi-unit Mailboxes

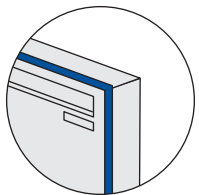

TE 110

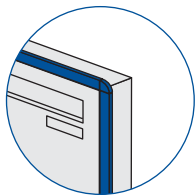

TE 120

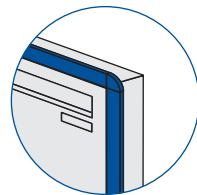

TE 190

Service – We Offer per Request:

- PVD coating (brass-look) and gilding of all stainless steel items
- V4A quality of all stainless steel surfaces
- varnishing in all RAL colours and custom powder colours
- individual surface design by means of silk screening
- Engravings and thru-engravings as well as adhesive lettering according to your specifications
- replacement part delivery for all products
- supplementary key for all mailbox locks
- manufacture of metal products of all types according to your specifications
- installation of complete multi-units on site

Product Care Tips

Please regularly clean all products, especially stainless steel products exposed to dirt or aggressive environmental influences (i.e. saline air). Only in this way is a long lifetime guaranteed. The powder coated surfaces as well as the stainless steel and anodised aluminium surfaces should be cleaned with warm water and washing-up liquid. Stainless steel components can also be treated with customary stainless steel cleaning agent. Please don't use any mechanically acting or oxide dissolving cleaning products. These corrode the anodised coating and destroy the surfaces. Door and lock hinges should be treated with a special cleaning agent, at least twice a year.

Guarantee

We issue a five year General Product Guarantee on all of our products.

Custom Production

We also manufacture mailboxes, doorbell plates, house numbers, among other products, according to your specifications. Simply let us know what you'd like.

Stands for Free-standing Multi-units

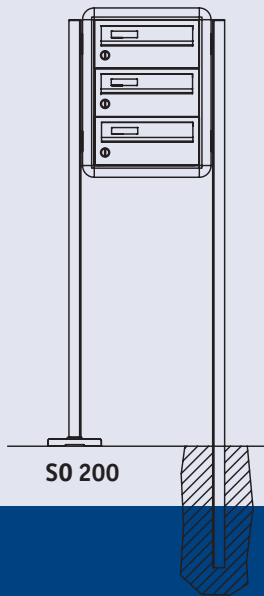

SO 200

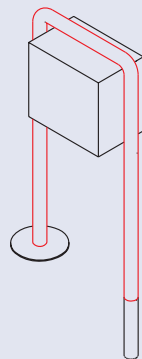

SO 400

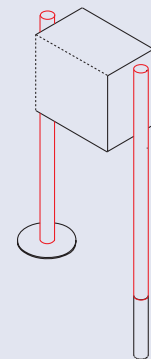

SO 401

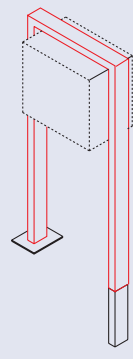

SO 440

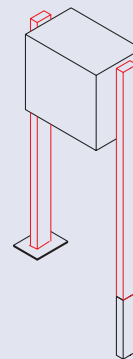

SO 441

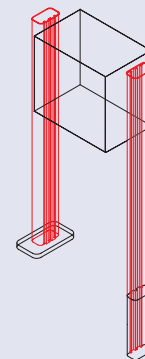

SO 491

SO 300, 310,
315, 320

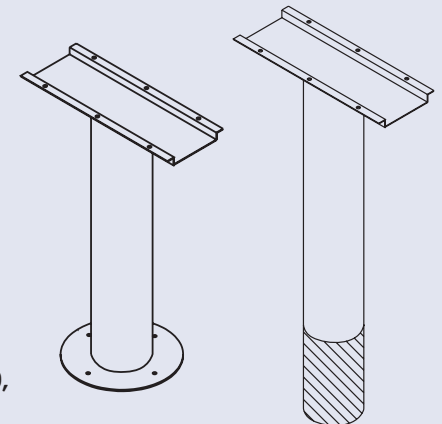



Publisher:
Max Knobloch Nachf. GmbH
May 2006

Models, programs and technical details subject to change, errors excepted. All contents are copyrighted. All copies and public use, even in part, without express consent are strictly prohibited.

Catalogue developed and conceived by
www.zwo-null.de

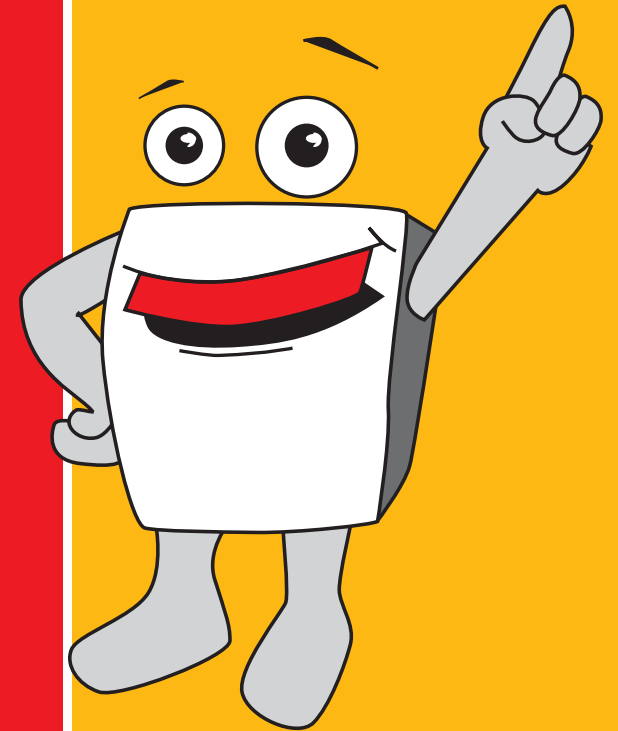

KNOBLOCH
METAL AT ITS BEST



Postbox Solutions Ltd
Malting Barn
Malting Lane
Dagnall
Herts.
HP4 1QY

Telephone: 0844 561 6726
Fax: 01442 842097

www.postboxsolutions.co.uk

