



POSTBOX SOLUTIONS
 The right choice for quality and service

KOBLOCH
 METAL AT ITS BEST

Commercial Mailbox Solutions

SURFACE MOUNTED MULTI-UNITS



**MULTI-UNIT MAILBOXES /
SURFACE MOUNTED MULTI-UNITS**



Multi-unit Mailboxes

Experience a quality that will convince you.

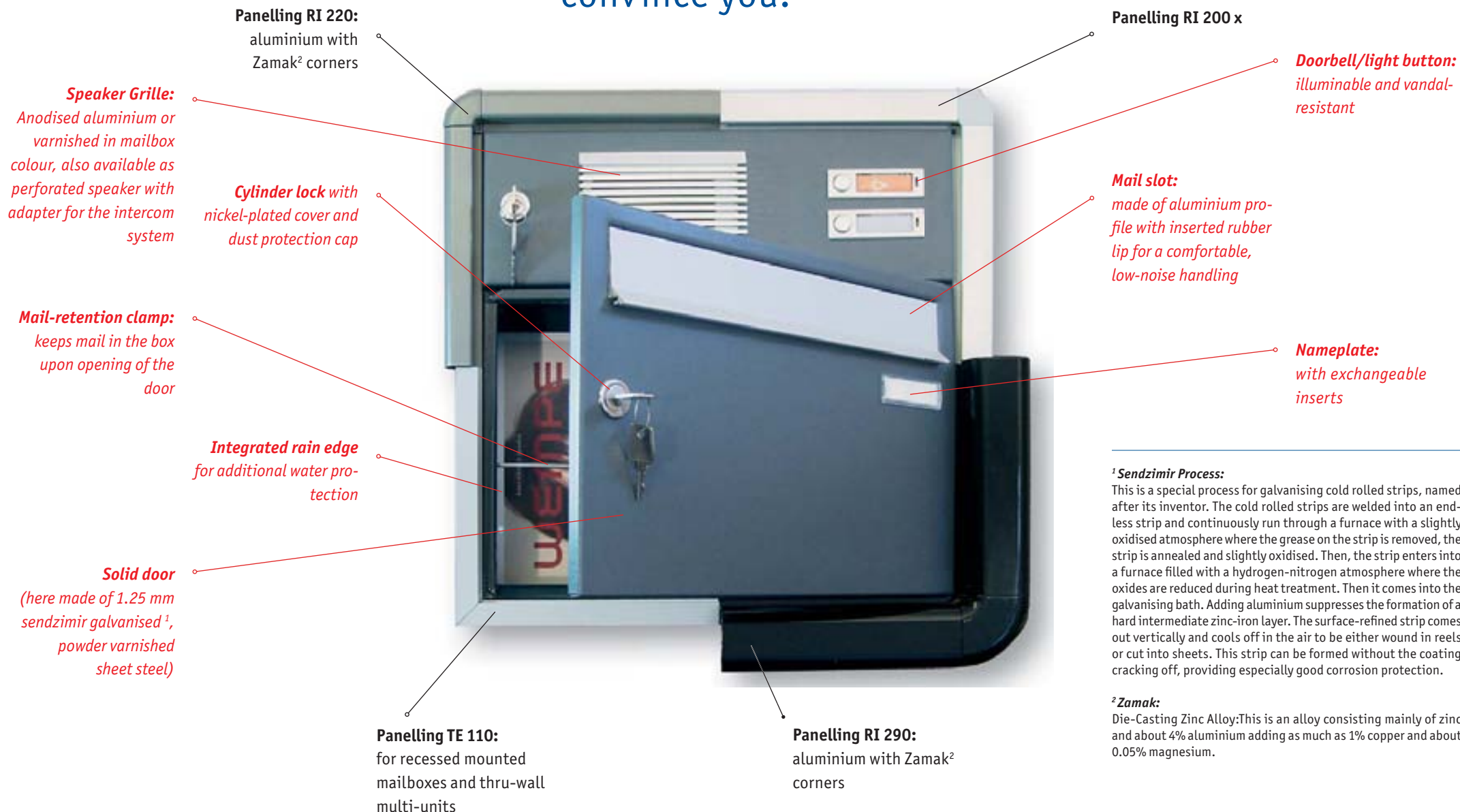

¹ Sendzimir Process:

This is a special process for galvanising cold rolled strips, named after its inventor. The cold rolled strips are welded into an endless strip and continuously run through a furnace with a slightly oxidised atmosphere where the grease on the strip is removed, the strip is annealed and slightly oxidised. Then, the strip enters into a furnace filled with a hydrogen-nitrogen atmosphere where the oxides are reduced during heat treatment. Then it comes into the galvanising bath. Adding aluminium suppresses the formation of a hard intermediate zinc-iron layer. The surface-refined strip comes out vertically and cools off in the air to be either wound in reels or cut into sheets. This strip can be formed without the coating cracking off, providing especially good corrosion protection.

² Zamak:

Die-Casting Zinc Alloy: This is an alloy consisting mainly of zinc and about 4% aluminium adding as much as 1% copper and about 0.05% magnesium.

Multi-unit mailboxes ...



... have to fulfill several expectations. First and foremost is function: the delivered mail has to be kept secure and dry. Larger parcels should fit well. This is regulated by the EN 13724. If there is less space, smaller mailboxes must be used. But, regardless of the size, quality and security come first. Other important selection criteria are stability, durability and longevity. Because mailboxes are installed in the entrance area, the design must be convincing. And last but not least, the cost-performance ratio plays a decisive role.

KOBLOCH stands for multi-unit mailboxes which consistently exceed these requirements. **In our complete product line you will find practically every mailbox imaginable – for the detached family house as well as for the skyscraper, from the solid model for the dormitory to the precious wood-paneled designer mailbox for the sophisticated owner.** All

of our mailboxes have high quality and meticulous processing in common. Built solidly and designed to be longlasting through an elaborate modular construction system, they can accommodate all construction conditions.

We'll introduce in greater detail what you'll need to make this possible on the following pages. There you'll also see how quickly and easily you can arrive at an entirely custom-made solution.

You can likewise select the right colour directly: you'll find a large number of standard colours starting on page 68. Furthermore, we can offer you more than 200 different RAL- and special shades. Processing is also possible for materials like brass and PVD-coated stainless steel and we are able to take on many additional special requests. With our mailbox calculation and graphic design software you can not only get an accurate picture of your mailbox system, but also easily calculate the dimensions and costs of all possible versions. Using our software is a piece of cake and makes deciding even from our extensive variety of products child's play.



You're interested in a multi-unit mailbox? *It's this easy.*

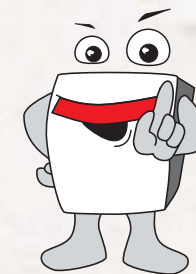

- 1 First choose your desired type of multi-unit.
- 2 According to the general description of the multi-unit, you'll find the components that can be used with it in their respective chapters. Here you can choose the type of mailbox, the kind of paneling and if applicable, the stand model.
- 3 You need functional components like doorbells and light buttons or intercom systems too? You also want to label your multi-unit with engravings, thru-engravings or adhesive lettering? Or you want to illuminate your letterbox system, furnish it with special security locks or other supplementary equipment, or install message boxes? You'll find all the components you need to do all of these things.
- 4 Now it's all about the colour: you can find all standard RAL -colours for powder varnishing and our standard anodising for aluminium surfaces. We'll be happy to meet your individual requirements – quickly and with cost-efficiency. Our colour service allows you to choose from over 200 colours. Please feel free to ask if you have any questions.
- 5 You would like to have a stainless steel multi-unit? No problem! Many multi-units can be ordered with a complete stainless steel finish.
- 6 We're also happy to manufacture according to your individual specifications. Our „special systems construction“ department realizes your individual ideas. Please feel free to ask!
- 7 Now only your purchase price is missing. To find it, please use one of the following options:
 - You can easily make your inquiry - by fax, email or simply call our friendly customer service, and you'll receive your individual, cost-free offer within a short time.
 - You could also use our calculation and graphic design software for multi-units and you'll immediately get a price and a picture of your desired multi-unit with all dimensions. This way you have a maximum of flexibility and service.

Have fun choosing! You can get help at any time with your customer service advisor.

Subject to technical changes and errors are excepted. Multi-unit dimensions are subject to minor tolerances. It is for example necessary to add 0.3 mm to a unit as a result of the powder coating. Our general terms and conditions apply.

They're always on top of it, these *surface mounted multi-unit mailboxes.*

fig. 1:
Surface mounted multi-unit
with vertical mailboxes,
panelling **RI 220 V** and
integrated message box

Just hanging around the whole day – why not, actually? At least, if one has the good qualities of these multi-units: similar to a chameleon, they adapt elegantly to their surrounding and become a part of the building's design. Fast and easy to install, the surface mounted multi-units are ideal for renovated entrance halls.

fig. 2:
Surface mounted multi-unit
with vertical mailboxes,
panelling **RI 240 V**

And you can always rely on the best quality, no matter if they are to be used outside or inside. Here too you have the choice between many multi-unit and panelling models. If you feel at a loss with all the possibilities, we would be happy to assist you.



fig. 1



fig. 2

Surface mounted multi-units with *horizontal mailboxes* are never narrow minded.

You find yourself in a tight spot: trying to put up a ton of mailboxes in a very small space. Claustrophobia, be gone! After all, there are surface mounted multi-unit mailboxes, which hold the mail horizontally. That doesn't mean, by the way, sacrificing individuality. To this end, we've devel-

oped various panellings that'll get on great with your building. The Knobloch customers service team will be happy to answer all your questions about this horizontal alternative. Our calculation and graphic design software can also help you further with convenience and ease.

*Surface mounted multi-unit
with horizontal mailboxes
and panelling RI 220 H*



fig. 1 & 2:
Surface mounted multi-unit
with horizontal mailboxes
and panelling RI 240 H

fig. 3 & 4:
Surface mounted multi-unit
with horizontal mailboxes
and panelling RI 220 H



**Here's
a tip:**

Please note that surface mounted multi-units with horizontal mailboxes can be up to 380 mm deep and because of this they could constrict driveways and footpaths, especially in stairways. In this case we recommend the use of vertical mailboxes.

Mailbox Models for Surface Mounted Multi-units with Horizontal Mailboxes

Mailbox with front removal (HA)

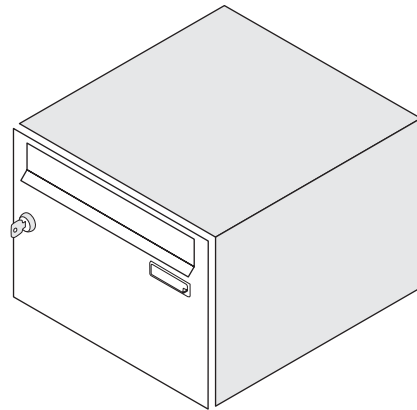

Function box (HA) with blind door (BT)

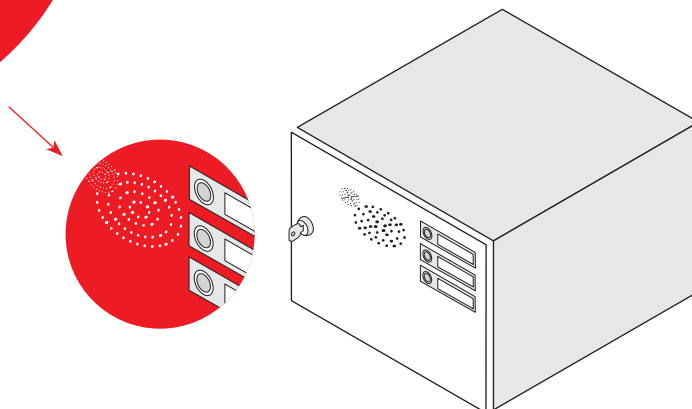

Note

For supplementary equipment with doorbells, light buttons, intercom systems, video modules and similar devices, the described mailbox models are modified to function boxes by the installation of a blind door..

Mailbox Model	Dimensions (Width x Height x Depth)	Mail Slot (Width x Height)	
HA 2611	260 x 110 x 380 mm	229 x 35 mm	
HA 2622	260 x 220 x 380 mm	229 x 35 mm	
HA 2633	260 x 330 x 380 mm	229 x 35 mm	
HA 3011	300 x 110 x 380 mm	265 x 35 mm	EN 13724
HA 3022	300 x 220 x 380 mm	265 x 35 mm	EN 13724
HA 3033	300 x 330 x 380 mm	265 x 35 mm	EN 13724
HA 3044	300 x 440 x 380 mm	265 x 35 mm	EN 13724
HA 3711	370 x 110 x 270 mm	325 x 35 mm	EN 13724
HA 3722	370 x 220 x 270 mm	325 x 35 mm	EN 13724
HA 3733	370 x 330 x 270 mm	325 x 35 mm	EN 13724
HA 3744	370 x 440 x 270 mm	325 x 35 mm	EN 13724
Extra deep: HA 37 are also available with a depth of 380 mm.			EN 13724

With box heights of 220 mm and greater, a 63 mm high insertion flap is possible, e.g. for especially thick pieces of mail.

With box heights of 220 mm and greater, a 63 mm high insertion flap is possible, e.g. for especially thick pieces of mail.



Panelling Types for Surface Mounted Multi-units

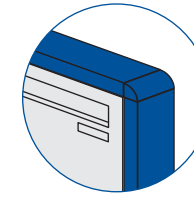
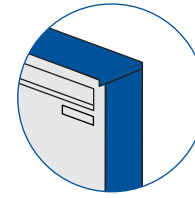
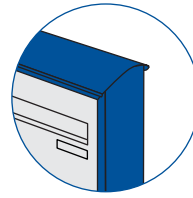
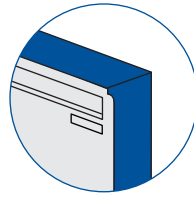
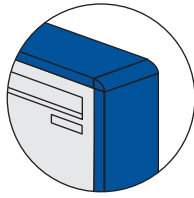

Product No.	RI 220 H	RI 240 H	RI 241 H	RI 243 H	RI 244 H	RI 290 H
Furnishings	Aluminium sheet panelling with aluminium profile rounded edges, Zamak corners, profile thickness 29 mm	Panelling with tight fitting sheets	Panelling with tight fitting sheets, front overlapping roof with punched rain edge	Tripartite arched panelling with panelling also on posts	Tripartite tight fitting panelling, front overlapping roof	Aluminium sheet panelling with aluminium profile rounded edges, Zamak corners, profile thickness 57 mm
Materials	Powder coated or anodised aluminium	Powder coated or anodised aluminium or stainless steel	Powder coated or anodised aluminium or stainless steel	Powder coated aluminium or stainless steel	Powder coated or anodised aluminium or stainless steel	Powder coated or anodised aluminium
Comments	Classic round-edge panelling, rain guard also possible	Panelling as cover bent from one piece, stretch-length of panelling max. 4000 mm	Panelling as cap bent from one piece, with integrated rain edge, stretch-length of panelling max. 4000 mm	Max. dimensions of individual mailbox 1000 x 1000 mm (height x width), ideal for detached and two family houses		Large round-edge panelling, rain guard also possible

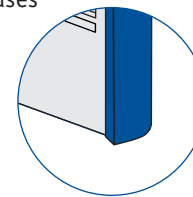

Tripartite arch of panelling type RI 243 H

Surface mounted multi-unit with horizontal mailboxes including function box, doorbell buttons and speaker grille, panelling RI 220 H



On the verge of winning *an award for variety.*



fig. 1:
*Surface mounted multi-unit
with vertical mailboxes and
panelling RI 240 V*

Our surface mounted multi-units with vertical mailboxes are so quick to install, that they already deserve a prize for that.

But that's not enough for them. They also score in the category of „outward appearance“, because their prestigious design blends so well with the existing interior.

The above mentioned variety award is also given for labeling possibilities as well as for message and function box alternatives.

And because one wants to dress up for the award show, we have designed a vast collection of beautiful panellings just for this occasion.

We would be happy to assist you with your decision. It's also possible to use our calculation and graphic design software to make your selection.

*Surface mounted multi-unit
with vertical mailboxes and
panelling RI 240 V*





fig. 1



fig. 2

Here's a tip:
 The battery installation with mailboxes S 2200, S 2215 and D 2200 constitutes an inexpensive alternative for the interior.



fig. 1 & 2:
Surface mounted multi-units with vertical mailboxes and panelling RI 220 V



S 2215

EN 13724



EN 13724



fig. 3:
Surface mounted multi-unit with vertical mailboxes and custom panelling



S 2200/S 2215 Memphis

Material:
galvanized steel sheet, powder varnished

Dimensions (width x height x depth):
355 x 330 x 100 mm (S 2215: 150 mm)

Feature:
prepared for battery installation through circular perforation,
recommended for interior

D 2200 Memphis VA

Material:
brushed stainless steel

Dimensions (width x height x depth):
355 x 330 x 100 mm

Feature:
prepared for battery installation through circular perforation,
recommended for interior

Multi-unit Mailbox Models for Surface Mounted Multi-units with Vertical Mailboxes

Mailbox with front removal (VA)

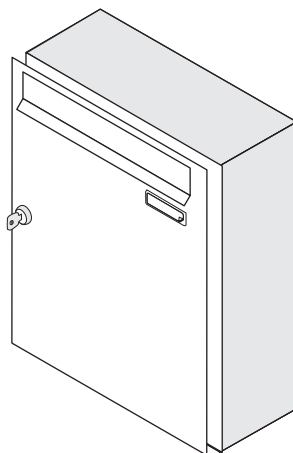

Function box (VA) with blind door (BT)

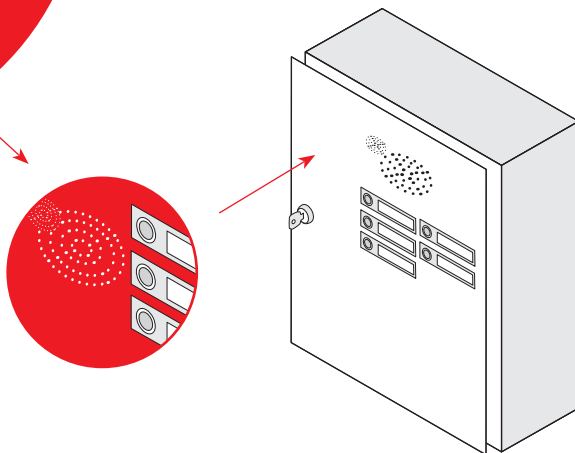

Mailbox Model	Dimensions (Width x Height x Depth)	Mail Slot (Width x Height)
VA 2633	260 x 330 x 100 mm	229 x 35 mm
VA 3033	300 x 330 x 100 mm	265 x 35 mm
VA 3044	300 x 440 x 100 mm	265 x 35 mm
Extra Deep: The model series VA 30 is also available in 160 mm depth.		
VA 3733	370 x 330 x 100 mm	325 x 35 mm
VA 3744	370 x 440 x 100 mm	325 x 35 mm
Extra Deep: The model series VA 37 is also available in 160 mm depth.		

The use of a 63 mm high insertion flap, for example for especially thick mail, is also possible.

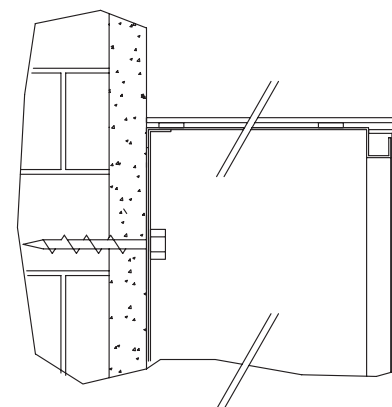

Detail drawing of surface mounting

Note

For supplementary equipment with doorbells, light buttons, intercom systems, video modules and similar devices the described mailbox models are modified to function boxes by the installation of a blind door.

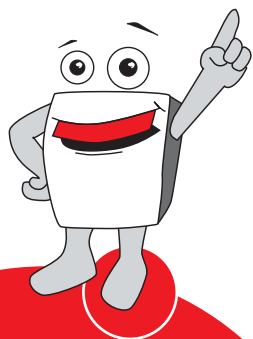

EN 13724

EN 13724

EN 13724

EN 13724

EN 13724

Panelling Models for Surface Mounted Multi-units

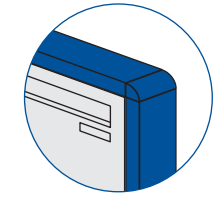
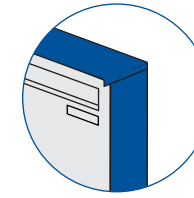
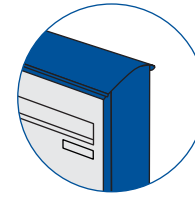
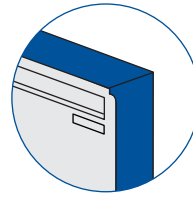
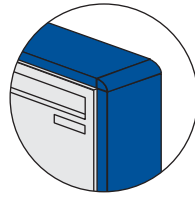
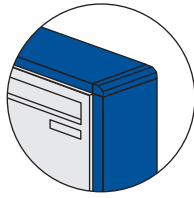

Product No.	RI 200 V	RI 220 V	RI 240 V	RI 241 V	RI 243 V	RI 244 V	RI 290 V
Furnishings	Aluminium profile panelling with rounded edges and aluminium die cast trapeziform corners	Aluminium sheet panelling with aluminium profile rounded edges, Zamak corners, profile thickness 29 mm	Panelling with tight fitting sheet	Panelling with tight fitting sheet, front overlapping roof with punched rain edge	Tripartite arched panelling with panelling also on posts	Tripartite, tight fitting panelling, front overlapping roof	Aluminium-sheet panelling with aluminium profile, rounded edges, Zamak corners, profile thickness 57 mm
Materials	Powder coated or anodised aluminium	Powder coated or anodised aluminium	Powder coated or anodised aluminium or stainless steel	Powder coated or anodised aluminium or stainless steel	Powder coated or anodised aluminium or stainless steel	Powder coated or anodised aluminium or stainless steel	Powder coated or anodised aluminium
Comments	Profile panelling, not possible with boxes with a depth of 160 mm	Classic round-edge panelling, rain guard also possible	Panelling as cap bent from one piece, stretch-length of panelling max. 4000 mm	Panelling as cap bent from one piece, with integrated rain edge, stretch-length of panelling max. 4000 mm	Max. dimensions of individual mailbox 1000 x 1000 mm (height x width), ideal for detached and two family houses		Large round-edge panelling, rain guard also possible

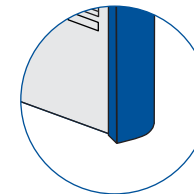

*Tripartite arch of panelling
type RI 243 V*

*** Anti-vandalism protection class 1**









Protection from damaging, theft and destruction without mechanical means. Doorbell and light buttons with combination frame of solid aluminium profile, doorbell button of aluminium with short travel (non-blockage), corrosion resistant and self-cleaning. Illuminated security nameplate of impact resistant, flame resistant plastic. Label exchange from the front – easy and convenient with the included keys.



Here's a tip:

Per multi-unit you'll also receive one special key for opening the nameplates and bell buttons to label them.

Assessories and Spare Parts for Multi-unit Mailboxes

	Product Description	Dimensions	Colours	Product No.
	Speaker Grille Anodised aluminium with universal adapter for all common loudspeakers <i>Notes about the function boxes you can find in the respective multi-unit chapters.</i>	95 x 80 mm (external dimensions)	Silver Bronze Gold White Black	15808 15809 15810 11178 15811
	Doorbell buttons, anodised aluminium, illuminable Anti-vandalism!* Nameplate Insert	82 x 24 mm (external dimensions) 49 x 13 mm	Silver Bronze Gold White Black	15800/LT 15803 15801/LT 15804 15802/LT 15805 11177/LT 15806 11234/LT 15807
	Light buttons, anodised aluminium, illuminable Anti-vandalism!*			
	Doorbell buttons, anodised aluminium, illuminable <i>Notes about the function boxes you can find in the respective multi-unit chapters.</i>	65 x 22 mm (external dimensions)	Brown White	10906 10907
	Soffit with fastener for illumination of buttons (with multiple buttons there will be one soffit per three buttons)	18 V/3 W		15532
	Doorbell button, round, stainless steel also available as illuminated stainless steel light button	ø 22 mm	Stainless Steel	10886
	Nameplate stainless steel self-adhesive, engravable, also available for screw fastening and in aluminium	60 x 20 mm	Stainless Steel	11184
	Nameplate (also available as clear glass) nameplate insert Nameplate Insert UV-resistant, printed on both sides „advertisements welcome“ or „please no advertisements“	74,5 x 22 mm 60,0 x 15 mm 60,0 x 15 mm	Transparent	16697 19742

Tip 1:

Per request we'd be happy to laser lock holes in the mailbox door, e.g. for the installation of cylinders from central lock units, according to your guidelines.





Tip 2:

Special locks, e.g. for a 2-point locking mechanism or as a locking bolt are also available upon request.

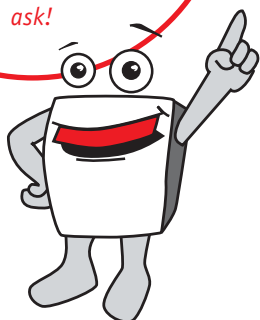
Tip 3:

All individual parts of a multi-unit e.g. insertion flaps, mailbox doors, locks, nameplates, light and doorbell buttons, are available as replacement parts per request. Just ask!

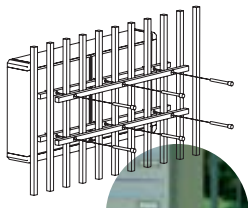

	Product Description	Dimensions	Colours	Product No.
	Message Box Includes 4 mm glass (polycarbonate), locking, multi-unit integration compatible, punched blind door	For doors 260 x 330 mm: > Punching: 180 x 270 mm For doors 300 x 330 mm: > Punching: 220 x 270 mm For doors 370 x 330 mm: > Punching: 290 x 270 mm	Matching multi-unit colour	SB2633 SB3033 SB3733
	Rain Guard Aluminium profile anodised or powder coated in the respective multi-unit colour – recommended for outdoor multi-units, possible only with panellings RI 220 and RI 290 , plaster cover frames TE 120 and TE 190 , and trim TE 130	Length corresponding to respective multi-unit width	Matching multi-unit colour	11175
	Mailbox Door Strengthened by "anti-vandalism", with security lock	H = 220 mm H = 330 mm H = 440 mm	Matching multi-unit colour	RP-240 RP-360 RP-480
	Locks and Keys – blank keys for standard and special locks – extra keys for standard locks (e.g. for caretaker or postman) – Replacement or spare key by noted key number – Lock for multi-unit with dust protection caps and 2 keys – Lock for multi-unit with dust protection caps and 2 keys, simultaneous locking			10710 10855 17131 11283 11144
	Installation Kits for Fences and Walls – for Mailbox models VA and HA, fastening bars for rear of multi-unit – for mailbox models VP and HP, distance piece for side fastening – shelf for multi-unit installation on wall ledge	Variable length	Varnished in multi-unit or fence colour	Kit MR-A Kit MR-P Kit MR-M

**Here's
a tip!**

*As a result of the most
modern, environmentally
friendly varnishing facilities,
we can offer you much more
than the usual colours
- without a price in-
crease.*

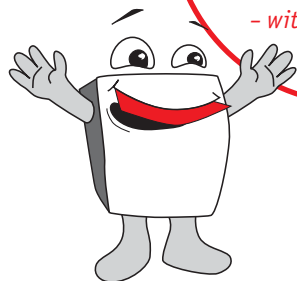

You haven't found the right colour tint in our standard offer? No problem: Simply select the right colour palette out of the RAL colour tray and order it as a custom colour. We'd also be happy to advise you with your selection. The shine of the colours remain intact for a long time thanks to the high-quality weather and UV-resistant powder coating used.

For all RAL colours out of our standard offer, we calculate a 20 % additional cost for all powder coated parts. The pictured RAL and anodised colour tints are only approximations. For the exact colour tint, the RAL colour cards and anodised pattern are binding.

Show Your True Colours!

Our colours and surfaces comply with the highest standards and requirements. Whether anodised aluminium, RAL powder coated or rust-free stainless steel, we stand behind our quality.

Standard RAL Colour Tints

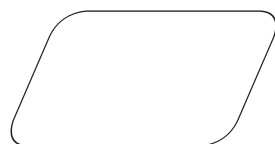

RAL 9016 Traffic-white



RAL 9010 Pure-white



RAL 7035 Light-grey



RAL 1014 Ivory

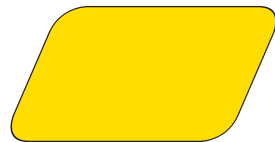

RAL 1018 Zinc-yellow

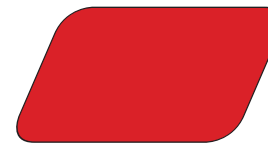

RAL 3020 Traffic-red



RAL 6005 Moss-green



RAL 5002 Ultramarine



RAL 8017 Chocolate-brown



RAL 7016 Charcoal-grey

Standard anodised colour tints for aluminium fronts



01 Silver EV 1



Here's a tip:

Logos, symbols and other lettering, as well as sizes are possible according to customer specification. Requirements: model must be delivered in vector graphic format. Your best bet is to contact your customer service person right away - he'd be happy to advise you.

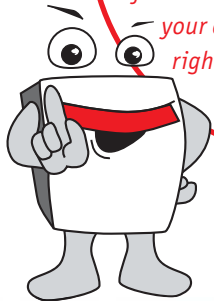

Establish Character!

No. 01 (Swiss)

ABCDEFGHIJKLMNOPQRSTUVWXYZ
abcdefghijklmnopqrstuvwxyz
1234567890

No. 02 (Swiss Outline)

ABCDEFGHIJKLMNOPQRSTUVWXYZ
abcdefghijklmnopqrstuvwxyz
1234567890

No. 03 (Avantgarde)

ABCDEFGHIJKLMNOPQRSTUVWXYZ
abcdefghijklmnopqrstuvwxyz
1234567890

Müller

Maier

Schmidt



Engraving

Lettering:
Swiss, Swiss Outline and Avantgarde

Technical Realisation:
Engraving in aluminium or stainless steel, black inlay

Letter Height:
10-100 mm

Special Features:
Other inlay colour according to customer specification possible

Thru-engraving

Lettering:
Swiss and Avantgarde possible

Technical Realisation:
Thru-engraving or thru-laser engraving in aluminium or stainless steel, background with UV-resistant white- or blue-coloured plastic film, illuminated upon request

Letter Height:
10-100 mm

Adhesive Lettering

Lettering:
Swiss and Avantgarde possible

Technical Realisation:
Colour film Scotchal, 100 series

Letter Height:
10-100 mm

Special Features:
No-shrink, flexible and smooth over creases and rivets, stream-jet cleaning resistant, UV light and weather proof (at least 5-7 years depending on pigment), resistant to temperature fluctuations (-40 C to + 95 C)



Publisher:
Max Knobloch Nachf. GmbH
May 2006

Models, programs and technical details subject to change, errors excepted. All contents are copyrighted. All copies and public use, even in part, without express consent are strictly prohibited.

Catalogue developed and conceived by
www.zwo-null.de

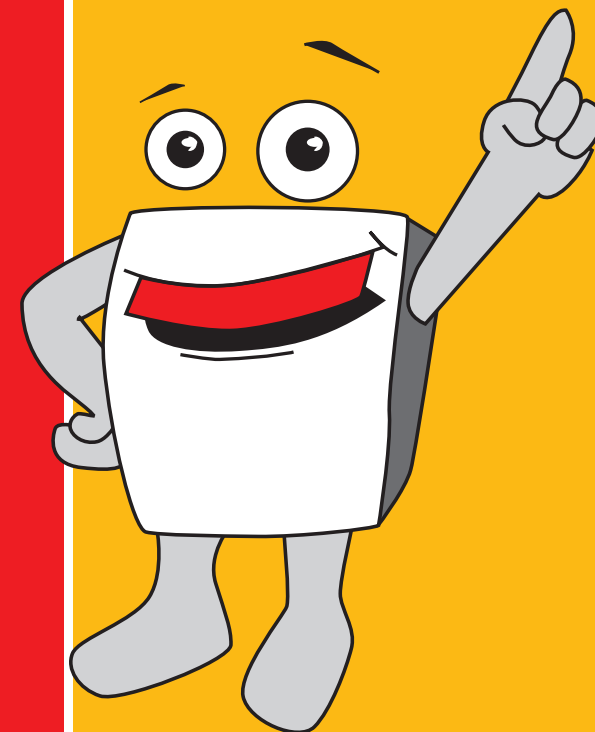

KNOBLOCH
METAL AT ITS BEST

Postbox Solutions Ltd
Malting Barn
Malting Lane
Dagnall
Hertfordshire
HP4 1QY

Tel.: 0844 561 6726

Fax: 01442 842097

Web: www.postboxsolutions.co.uk

Email: help@postboxsolutions.co.uk

