



POSTBOX SOLUTIONS
The right choice for quality and service

KOBLOCH
METAL AT ITS BEST

Commercial Mailbox Solutions

RECESSED MOUNTED MULTI-UNITS



MULTI-UNIT MAILBOXES /

**RECESSED MOUNTED
MULTI-UNITS**

1



Multi-unit Mailboxes

Experience a quality that will convince you.

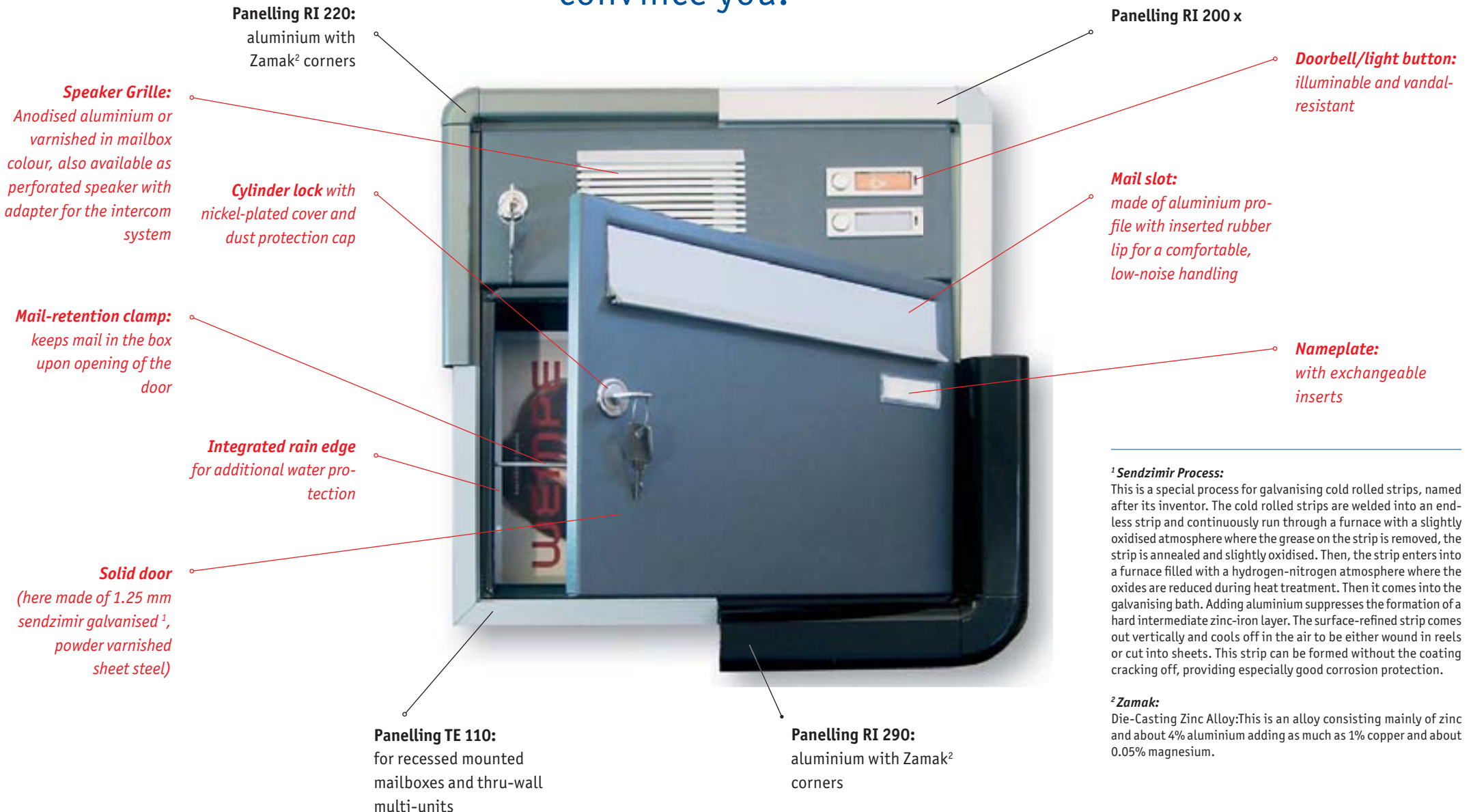

¹ Sendzimir Process:

This is a special process for galvanising cold rolled strips, named after its inventor. The cold rolled strips are welded into an endless strip and continuously run through a furnace with a slightly oxidised atmosphere where the grease on the strip is removed, the strip is annealed and slightly oxidised. Then, the strip enters into a furnace filled with a hydrogen-nitrogen atmosphere where the oxides are reduced during heat treatment. Then it comes into the galvanising bath. Adding aluminium suppresses the formation of a hard intermediate zinc-iron layer. The surface-refined strip comes out vertically and cools off in the air to be either wound in reels or cut into sheets. This strip can be formed without the coating cracking off, providing especially good corrosion protection.

² Zamak:

Die-Casting Zinc Alloy: This is an alloy consisting mainly of zinc and about 4% aluminium adding as much as 1% copper and about 0.05% magnesium.

Multi-unit mailboxes ...



... have to fulfill several expectations. First and foremost is function: the delivered mail has to be kept secure and dry. Larger parcels should fit well. This is regulated by the EN 13724. If there is less space, smaller mailboxes must be used. But, regardless of the size, quality and security come first. Other important selection criteria are stability, durability and longevity. Because mailboxes are installed in the entrance area, the design must be convincing. And last but not least, the cost-performance ratio plays a decisive role.

KOBLOCH stands for multi-unit mailboxes which consistently exceed these requirements. **In our complete product line you will find practically every mailbox imaginable – for the detached family house as well as for the skyscraper, from the solid model for the dormitory to the precious wood-paneled designer mailbox for the sophisticated owner.** All

of our mailboxes have high quality and meticulous processing in common. Built solidly and designed to be longlasting through an elaborate modular construction system, they can accommodate all construction conditions.

We'll introduce in greater detail what you'll need to make this possible on the following pages. There you'll also see how quickly and easily you can arrive at an entirely custom-made solution.

You can likewise select the right colour directly: you'll find a large number of standard colours starting on page 68. Furthermore, we can offer you more than 200 different RAL- and special shades. Processing is also possible for materials like brass and PVD-coated stainless steel and we are able to take on many additional special requests. With our mailbox calculation and graphic design software you can not only get an accurate picture of your mailbox system, but also easily calculate the dimensions and costs of all possible versions. Using our software is a piece of cake and makes deciding even from our extensive variety of products child's play.



You're interested in a multi-unit mailbox? *It's this easy.*

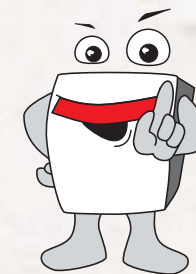

- 1 First choose your desired type of multi-unit.
- 2 According to the general description of the multi-unit, you'll find the components that can be used with it in their respective chapters. Here you can choose the type of mailbox, the kind of paneling and if applicable, the stand model.
- 3 You need functional components like doorbells and light buttons or intercom systems too? You also want to label your multi-unit with engravings, thru-engravings or adhesive lettering? Or you want to illuminate your letterbox system, furnish it with special security locks or other supplementary equipment, or install message boxes? You'll find all the components you need to do all of these things.
- 4 Now it's all about the colour: you can find all standard RAL -colours for powder varnishing and our standard anodising for aluminium surfaces. We'll be happy to meet your individual requirements – quickly and with cost-efficiency. Our colour service allows you to choose from over 200 colours. Please feel free to ask if you have any questions.
- 5 You would like to have a stainless steel multi-unit? No problem! Many multi-units can be ordered with a complete stainless steel finish.
- 6 We're also happy to manufacture according to your individual specifications. Our „special systems construction“ department realizes your individual ideas. Please feel free to ask!
- 7 Now only your purchase price is missing. To find it, please use one of the following options:
 - You can easily make your inquiry - by fax, email or simply call our friendly customer service, and you'll receive your individual, cost-free offer within a short time.
 - You could also use our calculation and graphic design software for multi-units and you'll immediately get a price and a picture of your desired multi-unit with all dimensions. This way you have a maximum of flexibility and service.

Have fun choosing! You can get help at any time with your customer service advisor.

Subject to technical changes and errors are excepted. Multi-unit dimensions are subject to minor tolerances. It is for example necessary to add 0.3 mm to a unit as a result of the powder coating. Our general terms and conditions apply.

Recessed Mounted: One can sink to this level.

Outstanding and flat: For the elegant recessed mounted multi-units this only appears to be a contradiction, for they leave, beside a good impression, smooth and classy walls as well. The architecture is enlivened, while the discreetly designed mailboxes simply vanish into the masonry.

To achieve this you don't have to make any concessions with the multi-unit's equipment or functionality: from almost limitless combinatory possibilities exactly the multi-unit mailbox you want will emerge. We are happy to help!

fig. 1:

*Recessed mounted multi-unit
with horizontal mailboxes
and plaster cover frame
TE 110*

fig. 2:

*Recessed mounted multi-unit with horizontal mailboxes
and plaster cover frame **TE 120***

fig. 3:

*Recessed mailbox-unit with vertical box, function box
with illuminated thru-engraving and plaster cover frame
TE 110 m; complete stainless steel front*



Some mail secrets stick *horizontally* under plaster.

This multi-unit model is doubly unobtrusive. For one, it disappears with minimum surface use elegantly under the plaster. And its horizontal mail intake saves space too. But we weren't frugal with the classy surface of these "space savers": individual plaster cover frames provide for a perfectly

smooth transition to the house wall. A wide choice and many possible combinations make your search for the right multi-unit easy. Just like our calculation and graphic design software for multi-unit mailboxes.

*Recessed mounted
multi-unit with horizontal
mailboxes and plaster cover
frame TE 120*



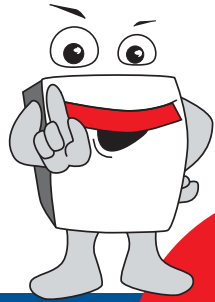

Note:

Please note that recessed mounted multi-unit mailboxes can be up to 380 mm deep, and therefore must go deep into the wall.



fig. 1:
Recessed mounted multi-unit with horizontal mailboxes and function box, plaster-covering frame **TE 110**, complete stainless steel front



fig. 2



Detail of doorbell/light buttons



Recessed mounted multi-unit with horizontal mailboxes and 2 large deposit boxes, plaster cover frame **TE 110**



fig. 3

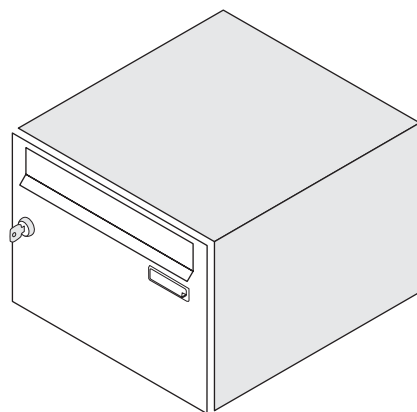

fig. 4

fig. 2-4:
Recessed mounted multi-units with horizontal mailboxes and plaster-cover frame **TE 110**

Mailbox Models for Recessed Mounted Multi-units with Horizontal Mailboxes

Mailboxes with front removal (HA)



Function box (HA) with blind door (BT)

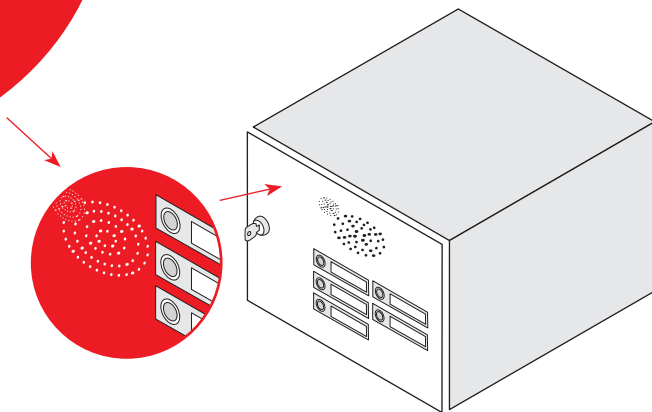

Note:

For supplementary equipment with doorbells, light buttons, intercom systems, video modules and similar devices, the described mailbox models are modified to function boxes by the installation of a blind door.



| Mailbox Models | Dimensions (Width x Height x Depth) | Mail Slot (Width x Height) | |
|--|--|-------------------------------|----------|
| HA 2611 | 260 x 110 x 380 mm | 229 x 35 mm | |
| HA 2622 | 260 x 220 x 380 mm | 229 x 35 mm | |
| HA 2633 | 260 x 330 x 380 mm | 229 x 35 mm | |
| HA 3011 | 300 x 110 x 380 mm | 265 x 35 mm | EN 13724 |
| HA 3022 | 300 x 220 x 380 mm | 265 x 35 mm | EN 13724 |
| HA 3033 | 300 x 330 x 380 mm | 265 x 35 mm | EN 13724 |
| HA 3044 | 300 x 440 x 380 mm | 265 x 35 mm | EN 13724 |
| HA 3711 | 370 x 110 x 270 mm | 325 x 35 mm | EN 13724 |
| HA 3722 | 370 x 220 x 270 mm | 325 x 35 mm | EN 13724 |
| HA 3733 | 370 x 330 x 270 mm | 325 x 35 mm | EN 13724 |
| HA 3744 | 370 x 440 x 270 mm | 325 x 35 mm | EN 13724 |
| Extra Deep: HA 37 are also available with a depth of 380 mm. | | | EN 13724 |

With box heights of 220 mm and greater, the use of a 63 mm high insertion flap, for example for especially thick mail, is also possible.

Plaster Cover Frames for Recessed Mounted Multi-units

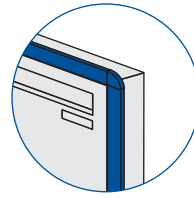
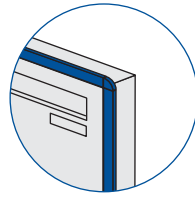
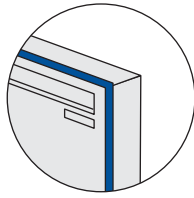

| Product No. | TE 110 | TE 120 | TE 190 |
|--------------------|--|---|---|
| Furnishings | Angular, metal profile plaster cover frame | Aluminium profile plaster cover frame with rounded edges and corners of Zamak, profile size 29 mm | Aluminium profile plaster cover frame with rounded edges and corners of Zamak, profile size 57 mm |
| Materials | Powder coated or anodised aluminium or powder coated stainless steel | Powder coated or anodised aluminium | Powder coated or anodised aluminium |
| Comments | Also available in brushed stainless steel | Classic round-edge frame, also available with rain guard | Large round-edge frame, also available with rain guard |



Here's a tip:

Sinking the multi-unit only partially into the wall is also possible. Doing this, part of the multi-unit protrudes out of the wall and is furnished with panelling. This variation is mainly used in the case of a lack of recess depth.

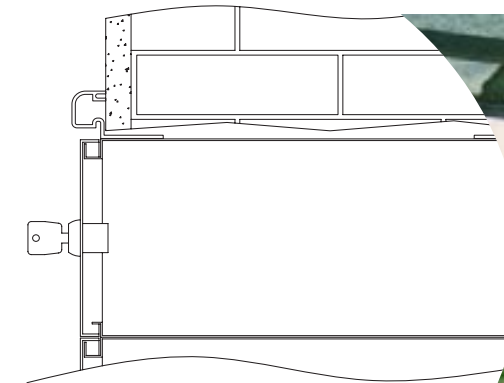

Installation example with plaster cover frame TE 120



Recessed mounted multi-unit with plaster cover frame TE 110

The mail? *Sunk under plaster.*



If you want, the mail goes downhill.

The decently designed recessed mounted multi-units adapt harmoniously to the building and accentuate the architecture. A further advantage: existing drive and walk ways are not restricted. All you need for the installation is a flat niche in the masonry. The appropriate plaster cover frames provide for a clean integration into the masonry.

Our customer service team will be happy to answer your questions. First steps in the planning can also be taken with our calculation and graphic design software.

*Recessed mounted mailbox-unit
without plaster cover frame with
mailbox VA 3044 and separate,
vaulted roof as per customer
specification*

fig. 1 & 2:
Recessed mounted multi-unit
with vertical mailboxes and
plaster cover frame **TE 120**



fig. 1

fig. 4:
Recessed mounted multi-unit
with vertical mailboxes and
plaster cover frame **TE 110**



fig. 3

fig. 4

fig. 3:
Recessed mounted multi-unit
with vertical mailboxes and
plaster cover frame **TE 120**



fig. 2



fig. 5:
Plaster cover frame **TE 110**



fig. 6:
Plaster cover frame **TE 120**



fig. 7:
Plaster cover frame **TE 190**

MULTI-UNIT MAILBOXES /

RECESSED MOUNTED MULTI-UNITS WITH VERTICAL MAILBOXES

12

Mailbox Models for Recessed Mounted Multi-units with Vertical Mailboxes

Mailboxes with front removal (VA)



Note

For supplementary equipment with doorbells, light buttons, intercom systems, video modules and similar devices, the described mailbox models are modified to function boxes by the installation of a blind door.

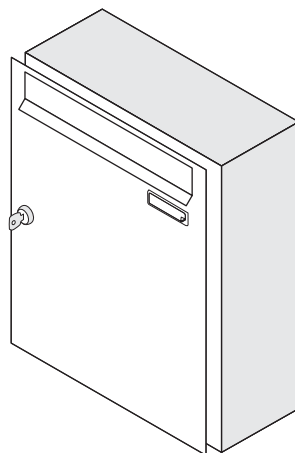

Function box (VA) with blind door (BT)

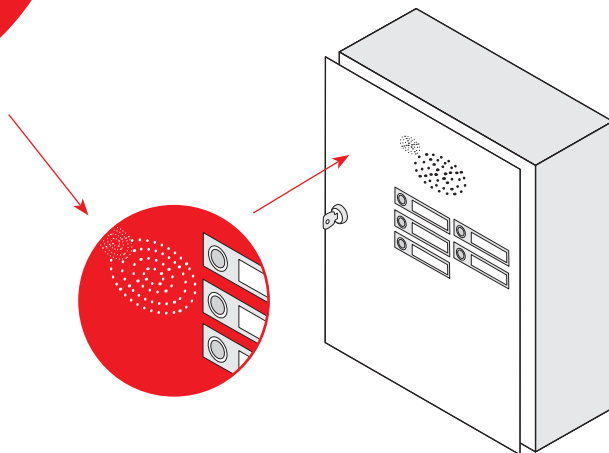

| Mailbox Model | Dimensions (Width x Height x Depth) | Mail Slot (Width x Height) | |
|---|--|-------------------------------|----------|
| VA 2633 | 260 x 330 x 100 mm | 229 x 35 mm | |
| VA 3033 | 300 x 330 x 100 mm | 265 x 35 mm | |
| VA 3044 | 300 x 440 x 100 mm | 265 x 35 mm | EN 13724 |
| Extra Deep: The VA 30 models are also available with a depth of 160 mm. | | | |
| VA 3733 | 370 x 330 x 100 mm | 325 x 35 mm | EN 13724 |
| VA 3744 | 370 x 440 x 100 mm | 325 x 35 mm | EN 13724 |
| Extra Deep: The VA 37 models are also available with a depth of 160 mm. | | | |

A 63 mm insertion flap is also possible e.g. for especially thick pieces of mail.

Plaster Cover Frames for Recessed Mounted Multi-unit Mailboxes

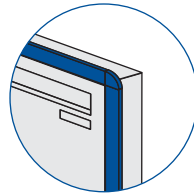
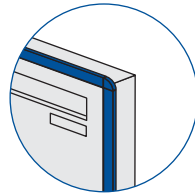
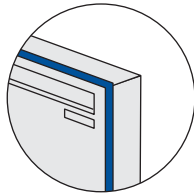

| Product No. | TE 110 | TE 120 | TE 190 |
|--------------------|--|---|---|
| Furnishings | Metal profile angular plaster cover frame | Aluminium profile plaster cover frame with rounded edges, Zamak corners, profile size 29 mm | Aluminium profile plaster cover frame with rounded edges, Zamak corners, profile size 57 mm |
| Materials | Powder coated or anodised aluminium or powder coated stainless steel | Powder coated or anodised aluminium | Powder coated or anodised aluminium |
| Comments | Also available in brushed stainless steel | Classic round-edge frame, also available with rain guard | Large round-edge frame, also available with rain guard |

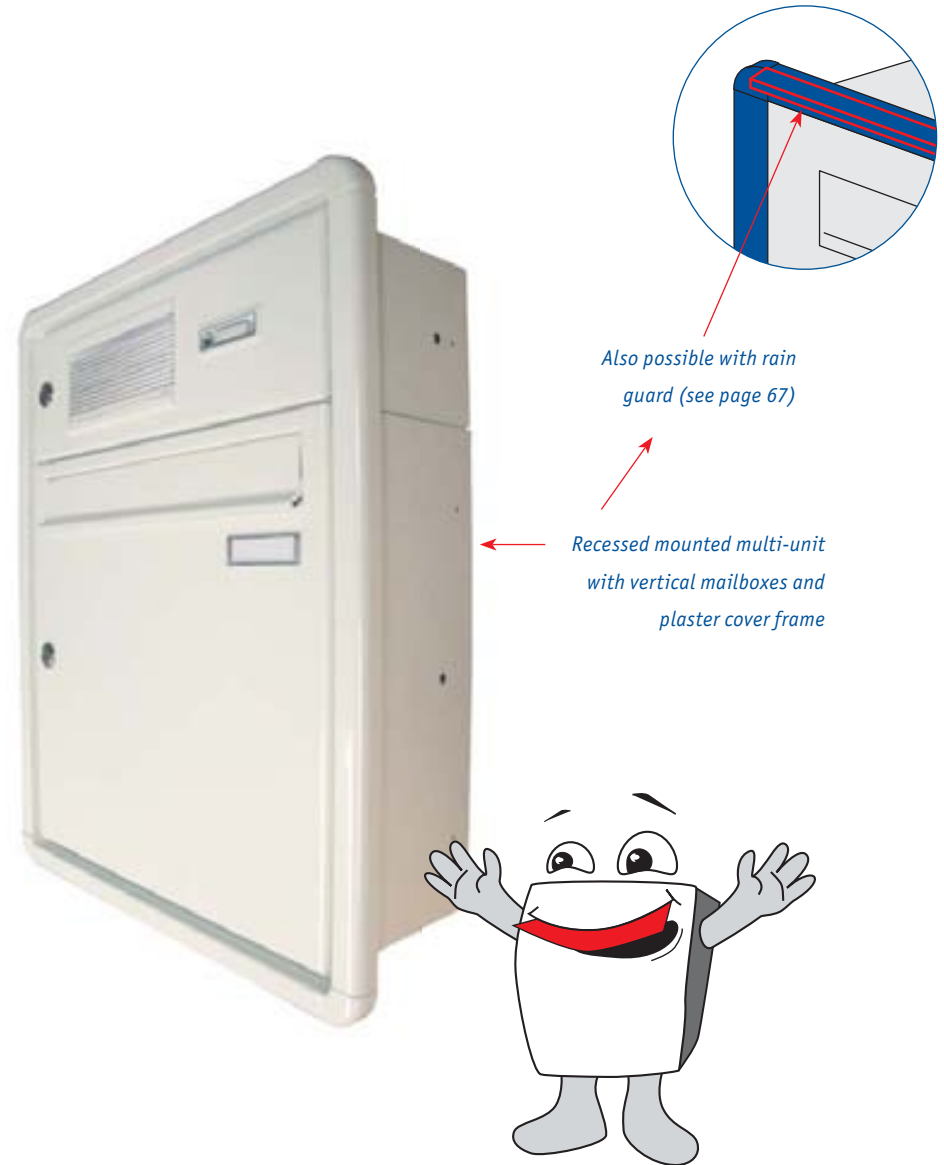

Also possible with rain guard (see page 67)

Recessed mounted multi-unit with vertical mailboxes and plaster cover frame

*** Anti-vandalism protection class 1**









Protection from damaging, theft and destruction without mechanical means. Doorbell and light buttons with combination frame of solid aluminium profile, doorbell button of aluminium with short travel (non-blockage), corrosion resistant and self-cleaning. Illuminated security nameplate of impact resistant, flame resistant plastic. Label exchange from the front – easy and convenient with the included keys.



Here's a tip:

Per multi-unit you'll also receive one special key for opening the nameplates and bell buttons to label them.

Assessories and Spare Parts for Multi-unit Mailboxes

| | Product Description | Dimensions | Colours | Product No. |
|---|---|---|--|--|
|  | Speaker Grille Anodised aluminium with universal adapter for all common loudspeakers <i>Notes about the function boxes you can find in the respective multi-unit chapters.</i> | 95 x 80 mm (external dimensions) | Silver Bronze Gold White Black | 15808 15809 15810 11178 15811 |
|  | Doorbell buttons, anodised aluminium, illuminable Anti-vandalism!* Nameplate Insert | 82 x 24 mm (external dimensions) 49 x 13 mm | Silver Bronze Gold White Black | 15800/LT 15803 15801/LT 15804 15802/LT 15805 11177/LT 15806 11234/LT 15807 |
|  | Light buttons, anodised aluminium, illuminable Anti-vandalism!* | | | |
|  | Doorbell buttons, anodised aluminium, illuminable <i>Notes about the function boxes you can find in the respective multi-unit chapters.</i> | 65 x 22 mm (external dimensions) | Brown White | 10906 10907 |
|  | Soffit with fastener for illumination of buttons (with multiple buttons there will be one soffit per three buttons) | 18 V/3 W | | 15532 |
|  | Doorbell button, round, stainless steel also available as illuminated stainless steel light button | ø 22 mm | Stainless Steel | 10886 |
|  | Nameplate stainless steel self-adhesive, engravable, also available for screw fastening and in aluminium | 60 x 20 mm | Stainless Steel | 11184 |
|  | Nameplate (also available as clear glass) nameplate insert Nameplate Insert UV-resistant, printed on both sides „advertisements welcome“ or „please no advertisements“ | 74,5 x 22 mm 60,0 x 15 mm 60,0 x 15 mm | Transparent | 16697 19742 |

Tip 1:

Per request we'd be happy to laser lock holes in the mailbox door, e.g. for the installation of cylinders from central lock units, according to your guidelines.





Tip 2:

Special locks, e. g. for a 2-point locking mechanism or as a locking bolt are also available upon request.

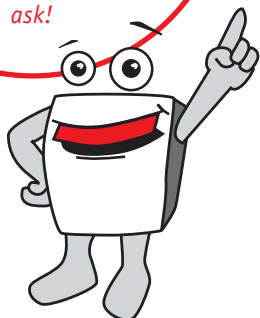
Tip 3:

All individual parts of a multi-unit e.g. insertion flaps, mailbox doors, locks, nameplates, light and doorbell buttons, are available as replacement parts per request. Just ask!

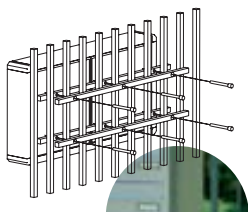

| | Product Description | Dimensions | Colours | Product No. |
|---|--|---|---|---|
|  | Message Box Includes 4 mm glass (polycarbonate), locking, multi-unit integration compatible, punched blind door | For doors 260 x 330 mm: > Punching: 180 x 270 mm For doors 300 x 330 mm: > Punching: 220 x 270 mm For doors 370 x 330 mm: > Punching: 290 x 270 mm | Matching multi-unit colour | SB2633 SB3033 SB3733 |
|  | Rain Guard Aluminium profile anodised or powder coated in the respective multi-unit colour – recommended for outdoor multi-units, possible only with panellings RI 220 and RI 290 , plaster cover frames TE 120 and TE 190 , and trim TE 130 | Length corresponding to respective multi-unit width | Matching multi-unit colour | 11175 |
|  | Mailbox Door Strengthened by "anti-vandalism", with security lock | H = 220 mm H = 330 mm H = 440 mm | Matching multi-unit colour | RP-240 RP-360 RP-480 |
|  | Locks and Keys – blank keys for standard and special locks – extra keys for standard locks (e. g. for caretaker or postman) – Replacement or spare key by noted key number – Lock for multi-unit with dust protection caps and 2 keys – Lock for multi-unit with dust protection caps and 2 keys, simultaneous locking | | | 10710 10855 17131 11283 11144 |
|  | Installation Kits for Fences and Walls – for Mailbox models VA and HA, fastening bars for rear of multi-unit – for mailbox models VP and HP, distance piece for side fastening – shelf for multi-unit installation on wall ledge | Variable length | Varnished in multi-unit or fence colour | Kit MR-A Kit MR-P Kit MR-M |

**Here's
a tip!**

As a result of the most modern, environmentally friendly varnishing facilities, we can offer you much more than the usual colours - without a price increase.

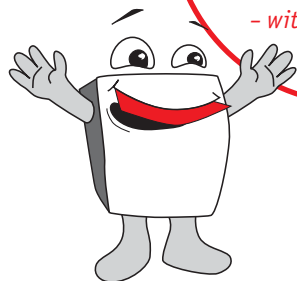

You haven't found the right colour tint in our standard offer? No problem: Simply select the right colour palette out of the RAL colour tray and order it as a custom colour. We'd also be happy to advise you with your selection. The shine of the colours remain intact for a long time thanks to the high-quality weather and UV-resistant powder coating used.

For all RAL colours out of our standard offer, we calculate a 20 % additional cost for all powder coated parts. The pictured RAL and anodised colour tints are only approximations. For the exact colour tint, the RAL colour cards and anodised pattern are binding.

Show Your True Colours!

Our colours and surfaces comply with the highest standards and requirements. Whether anodised aluminium, RAL powder coated or rust-free stainless steel, we stand behind our quality.



Standard RAL Colour Tints

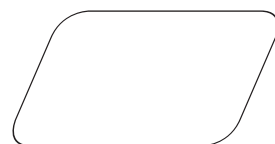

RAL 9016 Traffic-white



RAL 9010 Pure-white



RAL 7035 Light-grey



RAL 1014 Ivory

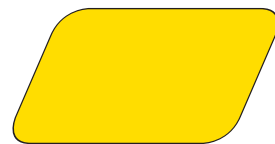

RAL 1018 Zinc-yellow

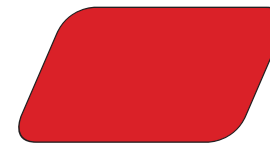

RAL 3020 Traffic-red



RAL 6005 Moss-green



RAL 5002 Ultramarine



RAL 8017 Chocolate-brown



RAL 7016 Charcoal-grey

Standard anodised colour tints for aluminium fronts



01 Silver EV 1

Here's a tip:

Logos, symbols and other lettering, as well as sizes are possible according to customer specification. Requirements: model must be delivered in vector graphic format. Your best bet is to contact your customer service person right away – he'd be happy to advise you.

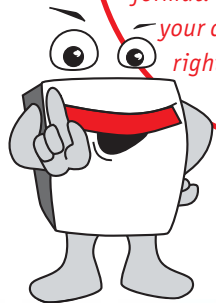

Establish Character!

No. 01 (Swiss)

ABCDEFGHIJKLMNOPQRSTUVWXYZ
abcdefghijklmnopqrstuvwxyz
1234567890

No. 02 (Swiss Outline)

ABCDEFGHIJKLMNOPQRSTUVWXYZ
abcdefghijklmnopqrstuvwxyz
1234567890

No. 03 (Avantgarde)

ABCDEFGHIJKLMNOPQRSTUVWXYZ
abcdefghijklmnopqrstuvwxyz
1234567890

Müller

Maier

Schmidt



Engraving

Lettering:
Swiss, Swiss Outline and Avantgarde

Technical Realisation:
Engraving in aluminium or stainless steel, black inlay

Letter Height:
10–100 mm

Special Features:
Other inlay colour according to customer specification possible

Thru-engraving

Lettering:
Swiss and Avantgarde possible

Technical Realisation:
Thru-engraving or thru-laser engraving in aluminium or stainless steel, background with UV-resistant white- or blue-coloured plastic film, illuminated upon request

Letter Height:
10–100 mm

Adhesive Lettering

Lettering:
Swiss and Avantgarde possible

Technical Realisation:
Colour film Scotchal, 100 series

Letter Height:
10–100 mm

Special Features:
No-shrink, flexible and smooth over creases and rivets, stream-jet cleaning resistant, UV light and weather proof (at least 5–7 years depending on pigment), resistant to temperature fluctuations (-40 C to + 95 C)



Publisher:
Max Knobloch Nachf. GmbH
May 2006

Models, programs and technical details subject to change, errors excepted. All contents are copyrighted. All copies and public use, even in part, without express consent are strictly prohibited.

Catalogue developed and conceived by
www.zwo-null.de

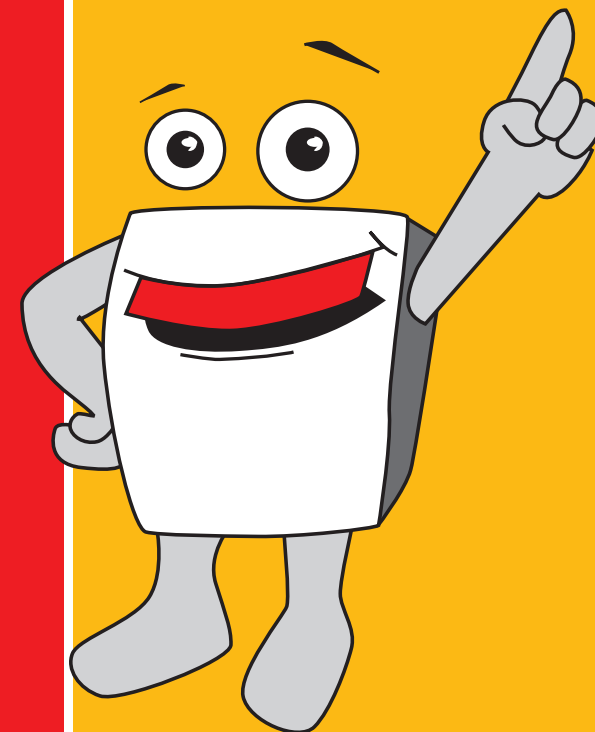

KNOBLOCH
METAL AT ITS BEST

Postbox Solutions Ltd
Malting Barn
Malting Lane
Dagnall
Hertfordshire
HP4 1QY

Tel.: 0844 561 6726

Fax: 01442 842097

Web: www.postboxsolutions.co.uk

Email: help@postboxsolutions.co.uk

